



OPERATING INSTRUCTIONS

Magnetic length and angle measuring system **MPI-15**

Software version E0.2



OPERATING INSTRUCTIONS

Magnetic length and angle measuring system **MPI-15**

Software version E0.2

Subject to modification in technic and design.

Contents	<i>pag.</i>
1. Safety instructions	3
2. System description	3
3. Installation	4
3.1. Display and battery case installation	4
3.2. Magnetic band installation	4
4. Keys' function	4
5. Operating mode	5
5.1. Commissioning	5
5.2. Absolute mode / incremental mode selection	5
5.3. Unit of measure selection	5
5.4. Direct loading of the absolute reference value	5
5.5. Direct reset of incremental reference value	5
5.6. Access the absolute reference value setting procedure	5
5.7. Access the offset value setting procedure	5
5.8. Switching the device ON and OFF	5
5.9. Battery level check	6
6. Programming mode	6
7. Sensor calibration procedure	6
8. Angle measurement	6

1. Safety instruction

The product has been developed and built in accordance with the recognized rules of technology. The units have left the manufacturing plant ready to operate and in safe condition.

To keep the units in this condition, it is necessary that the units are installed and operated properly, in a safety and hazard-conscious manner, under observance of this operating manual and in particular of the following safety precautions.

Make sure that the personnel has read and understood the operating manual and in particular the "Safety Instructions" chapter.

In addition to the operating manual, the generally applicable legal and other binding regulations for accident prevention and environmental protection must be observed and ensured.

This manual is intended as a supplement to already existing documentation (catalogues, data sheets and assembly instructions).

Proper use

The units may only be operated:

- in the properly installed state and
- in accordance with the specifications of the technical data.

! Operation not covered by the specified descriptions/parameters, in conjunction with the systems/machines/processes to be controlled/monitored, is improper and can lead to:

- fatal injuries,
- serious damage to health,
- property damage or
- damage to the units

! As a result of a failure/malfunction or incorrect operation of the units,

- a life-threatening danger,
- health risks or
- a danger of property or environmental damage could result, if the units are used to control/monitor machines or processes. Then appropriate safety precautions must be taken.

Do not open the housing of the units or make any changes to it. Tampering with the units can have a negative effect on their operating safety, causing danger. Do not make repairs on the units. Return defective units to the manufacturer.

The correct behaviour of the MPI-15 is assured when the device is used in combination with the magnetic band M-BAND-10. The manufacturer is not responsible for possible malfunctions caused by the use of a different magnetic band.

2. System description

The MPI-15, made of a LCD multifunction display with integrated position sensor, combined with the magnetic band M-BAND-10, is a complete system for the measurement of linear and angular displacement. Characterised by extremely easy assembly, it allows precise alignment and positioning, reducing times and machining procedures to a minimum.

- Multifunction LCD with 5 function keys.
- Absolute/ incremental mode.
- Programmable offset function.
- External battery power supply 1.5 VDC.
- Buffered memory during battery substitution.
- Accidental polarity inversion protection.
- Magnetic sensor envelope material: anodized aluminium.

MPI-15 Technical data	
Battery life	1.5 years (C-type battery)
Resolution (1)	0.1 mm - 0.01 in - 0.01°
Accuracy (2)	0.1 mm
Repeatability (3)	0.01 mm
Operating speed	max 5 m/s
Self-diagnostic	battery check, sensor check, magnetic tape check
Programmable measuring unit	millimetres, inches, degrees (angles)
Working temperature	from 0°C to 50°C
Storage temperature	from -20°C to 70°C
Humidity	max 95% at 25°C without condensation
Protection level	IP40 whole device IP54 front side according to IEC 529 IP67 magnetic sensor
Interference protection	class 3 according to IEC 801

- (1) Resolution: the smallest change in length that the system is capable of displaying.
- (2) Precision: the maximum deviation of the value measured by the system from the actual one.
- (3) Repeat accuracy: the degree of closeness between a series of measures of the same sample, when the single measurements are carried out leaving the measurement conditions unchanged.

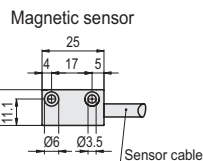
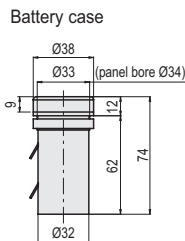
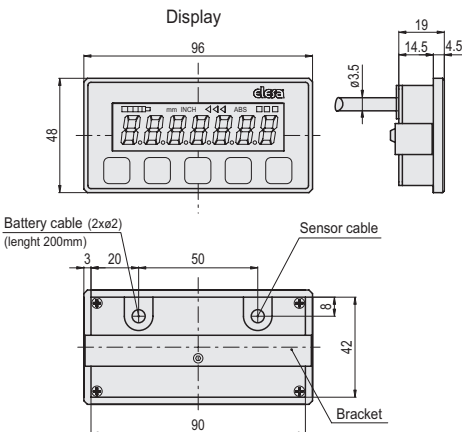

The magnetic band M-BAND-10 is made of two separate parts: the magnetic band and the cover strip. The magnetic band is made of a magnetic tape, a carrier strip and an adhesive tape (Fig. 1). The cover strip is made of a protection strip and an adhesive tape (Fig. 2).

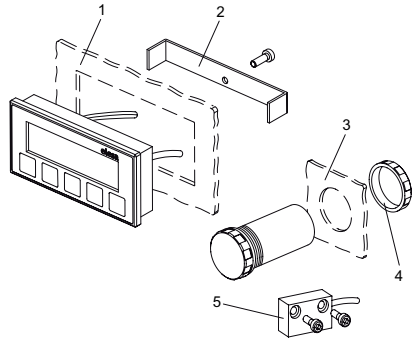
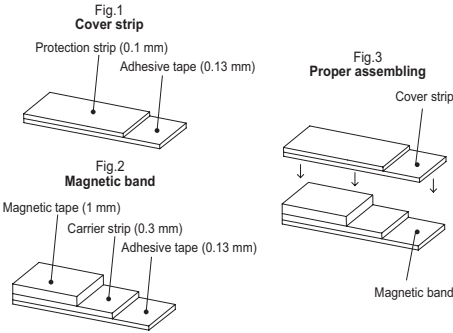

M-BAND-10 Technical data	
Accuracy class	± 40 µm
Material	magnetic tape: nitrilic rubber
	carrier strip: stainless steel
	cover strip: stainless steel
	acrylic adhesive tape
Width	magnetic band: 10 mm ± 0.20 mm
	cover strip: 10 mm ± 0.20 mm
Thickness	magnetic band: 1.43 ± 0.15 mm
	cover strip: 0.23 mm
Magnetic pole pitch	5 mm
Operating and storage temperature	min -40°C max +100°C
Linear thermic expansion factor	17 x 10 ⁻⁶ /K

3. Installation

3.1 Display and battery case installation

- 1) Make a drilling of 42 ^{+0.2/+0.5} mm in the metal sheet for the installation of the display.
- 2) Fix the display to the panel by using the specific mounting bracket (the screw is included in the supply).
- 3) Make a drilling of diameter 34 ^{+0.2/+0.5} mm in the metal sheet for the installation of the battery case.
- 4) Fix the battery case to the panel by using the specific nut.
- 5) Fix the magnetic sensor by using M3 screws (not included in the supply). Distance between sensor and magnetic tape to ensure a correct reading of the displacement: max 2.5 mm.

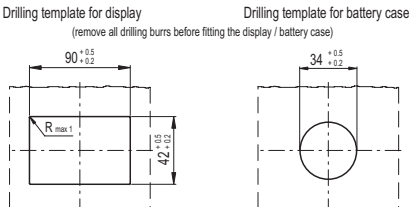

! The cable layout should be outlined to prevent damages due to cable strain or contacts of the cable with other machine components. It is recommended that the cable is installed sufficiently far from magnetic / electromagnetic sources.

Battery type

Batteries are not supplied together with the MPI-15. The following standard battery is recommended: 1 x C battery

Battery substitution

When the display shows the battery symbol, the battery should be replaced as soon as possible. After the removal of the battery, the display memory is buffered for approximately 60 seconds. Substitute the battery within this time frame.

3.2 Magnetic band installation

The cover strip must be installed over the magnetic band to protect it from possible mechanical damages.

- 1) Clean the mounting surface carefully.
- 2) Remove the protective foil from the adhesive tape of the magnetic band.
- 3) Stick the magnetic band on the mounting surface.
- 4) Clean the surface of magnetic band carefully.
- 5) Remove the protective foil from the adhesive tape of the cover strip.
- 6) Stick the cover strip on the magnetic band.
- 7) In the absence of a seat for the housing of M-BAND-10, secure the ends of the cover strip to prevent unintentional peeling.

! The mounting surface must be flat. Buckles or bumps will lead to measuring inaccuracies.

To guarantee an optimal adhesion of the adhesive tapes, the mounting surfaces must be perfectly cleaned, dry and smooth. The following surface roughness is recommended: Ra ≤ 3,2 N8 (Rz ≤ 25). To maximize the adhesion install the strip applying pressure. Gluing should preferably be carried out at temperatures between 20 °C to 30 °C and in dry atmosphere.

Once the installation is completed, the calibration procedure must be carried out as shown at Paragraph 7.

4. Keys' function

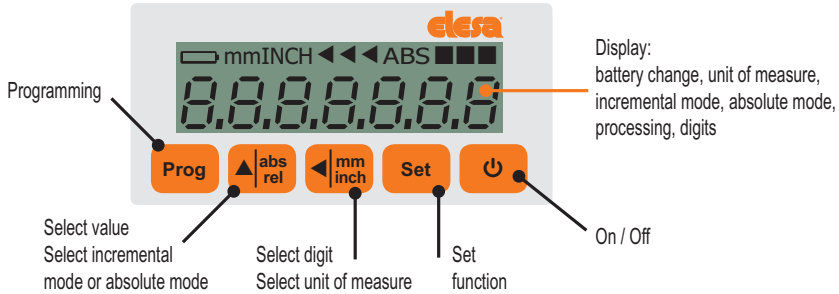

5. Operating mode

5.1 Commissioning

Use the key to switch on / off the system.

5.2 Absolute mode / incremental mode selection

Press the key to switch from absolute mode to incremental mode and vice versa. The selected mode is indicated on the display by the symbols:

ABS - absolute

◀◀◀ - incremental

When the incremental mode (◀◀◀) is selected, the incremental counter is automatically set to zero.

5.3 Unit of measure selection

If parameter *units* is enabled (*ENABLE*), the unit of measure is selected by pressing the key. The available options are the following: mm (0.1), inch (0.001), degrees (0.01), degrees (0.1), degrees (1).

If parameter *units* is disabled (*DISABLE*), the unit of measure cannot be changed in the operating mode.

5.4 Direct loading of the absolute reference value

If parameter *LoadOrG* is enabled (*ENABLE*) and the absolute mode is selected (**ABS**), the reference value is directly loaded by pressing the key.

If parameter *LoadOrG* is disabled (*DISABLE*) and the absolute mode is selected (**ABS**), the reference value is loaded by pressing the + keys.

The reference value is loaded according to the selected unit of measure.

5.5 Direct reset of incremental reference value

If parameter *CLr_rEL* is enabled (*ENABLE*) and the incremental mode is selected (◀◀◀), the display can be set to zero by pressing the key.

If parameter *CLr_rEL* is disabled (*DISABLE*), the display can be set to zero only by switching from absolute mode (**ABS**) to incremental mode (◀◀◀).

5.6 Access the absolute reference value setting procedure

If parameter *ProGOrG* is enabled (*ENABLE*) and the absolute mode is selected (**ABS**), the absolute reference value setting procedure is directly run by pressing the + keys.

If parameter *ProGOrG* is disabled (*DISABLE*), the absolute reference value setting procedure can be run only accessing the programming mode.

5.7 Access the offset value setting procedure



If parameter *ProGOfS* is enabled (*ENABLE*) and the absolute mode is selected (**ABS**), the offset value setting procedure is directly run by pressing the + keys.

If parameter *ProGOfS* is disabled (*DISABLE*), the offset value setting procedure is directly run only accessing the programming mode.



5.8 Switching the device ON and OFF

If parameter *on-Off* is set to *direct*, the display is immediately switch off by pressing the key.

If parameter *on-Off* is set to *dEL'd*, the display is switch off by pressing the key for 4 seconds.



 The display is immediately switched on by pressing the  key independently from the value of the *on-OFF* parameter.

5.9 Battery level check



The battery tension is shown on the display by pressing the  +  keys. The display automatically switch to the normal mode after a few seconds.

6. Programming mode

Press  for about 4 seconds **to enter** the programming mode. The time remaining to enter the programming mode is shown on the display.

Press  (forward)  (backward) **to scroll** the function parameters described below.

Press  **to access** the current function parameters.



Press the  **to store** the parameters value or press  **to exit** from the selected function without saving.

Press  **to leave** the programming mode. The device will exit from the programming mode automatically 30 seconds after the last key is pressed.

The available parameters and their description are reported in the table (see pages 7, 8).

7. Sensor calibration procedure

The sensor calibration procedure must be carried out at the initial machine setting and in case of substitution of the position indicator.

- Install the position indicator as described in Paragraph 3.
- Enter the programming mode and run the sensor calibration procedure by means of the parameter *SETUP*.
- A confirmation message is displayed:
press  to confirm,  to exit the procedure.
- The following message is displayed: PRESS SET TO START SETUP. Press  to confirm.
- Move the sensor for about 100 mm. The display shows the procedure progress.
- Once the procedure is completed, the display switch to the operating mode.

8. Angle measurement

For angle measurement on a circular track, one of the available angular unit of measure (degrees (0.01), degrees (0.1), degrees (1)) must be selected by means of the  key or by means of the *rES* parameter. When an angular unit of measure is selected, the measured distance is multiplied by the coefficient defined by the parameter

ANG_cor, which must be set as follows:

$$ANG_cor = \frac{3600}{2 \pi R}$$

Where R is the radius of the circular track measured in mm.









 The *ANG_cor* parameter is neglected when a linear unit of measure is selected (mm, inch)

Example: circular track with radius R=1000 mm

$$ANG_cor = \frac{3600}{2 \pi 1000} = 0.57324$$

Parameter	Description	Available options	Std Value
<i>dir</i>	Counting Direction	Press to choose between <i>-dir</i> (negative) and <i>dir-</i> (positive).	<i>-dir</i>
<i>Origin</i>	Reference Value	The parameter value is shown on the display. Press to increase the flashing number/mark. Press to select the next number. Programmable value 0.00000 +/- 9.99999 .	<i>0.0</i>
<i>Offset</i>	Offset Value	The parameter value is shown on the display. Press to increase the flashing number/mark. Press to select the next number. Programmable value 0.00000 +/- 9.99999 .	<i>0.0</i>
<i>Units</i>	Unit of measure	The parameter enables or disables the units of measure key in the operating mode. Press or to choose between: EnAbLE : the unit of measure can be changed by pressing the key in the operating mode. diSAbLE : the unit of measure cannot be changed in the operating mode.	<i>diSAbLE</i>
<i>rES</i>	Resolution	The parameter allows defining the resolution of the display. Press or to choose between the available options: mm (0.1), inch (0.001), degrees (0.01), degrees (0.1), degrees (1) .	<i>mm 0.1</i>
<i>Lin_cor</i>	Linear scale coefficient	The parameter value is shown on the display. Press to increase the flashing number/mark. Press to select the next number. Programmable value 0.00001 +/- 9.99999 . 0.00000 cannot be accepted (the coefficient is automatically set to 1.00000).	<i>1.00000</i>
<i>Ang_cor</i>	Angular scale coefficient	The parameter value is shown on the display. Press to increase the flashing number/mark. Press to select the next number. Programmable value 0.00000 +/- 9.99999 . 0.00000 cannot be accepted (the coefficient is automatically set to 1.00000). See Par. 8 for angle measurement description.	<i>1.00000</i>
<i>AutoOFF</i>	Automatic Switch-off	The parameter enables or disables the automatic switch-off. Use and to choose between: EnAbLE : the display automatically switches off after the selected period of time (parameter <i>t-out</i>). diSAbLE : display does not switch-off automatically.	<i>diSAbLE</i>
<i>t-out</i>	Switch-off time	Use and to choose between the available values (in hours). Select 0.2;0.5;1;2;4;8 (in hours). When unused, the display automatically switch off after the switch-off time .	<i>0.2 h</i>
<i>on-OFF</i>	Switch-off mode	The parameter allows defining the switch-off mode. Use and to choose between: diREct : the display switches off immediately by pressing dEL't : the display switches off by pressing for about 4 seconds	<i>diREct</i>
<i>LoadORg</i>	Reference value loading mode	The parameter allows defining the reference value loading mode. Use and to choose between: EnAbLE : in the absolute mode (<i>ABS</i>) the absolute reference value is loaded by pressing diSAbLE : in the absolute mode (<i>ABS</i>) the absolute reference value is loaded by pressing +	<i>diSAbLE</i>
<i>CLr_reL</i>	Incremental counter reset mode.	The parameter allows defining the incremental counter reset mode. Use and to choose between: EnAbLE : in the incremental mode (<i>◀◀</i>) the incremental counter is set to zero by pressing diSAbLE : in the incremental mode (<i>◀◀</i>) the incremental counter cannot be set to zero (the incremental counter is set to zero when the incremental mode is selected).	<i>diSAbLE</i>

Magnetic length and angle measuring system MPI-15

Parameter	Description	Available options	Std Value
<i>ProGOrG</i>	Direct reference value setting	The parameter allows enabling the direct reference value setting procedure. Use  and  to choose between: <i>EnAbLE</i> : in the operating mode the parameter <i>OrIGin</i> can be modified by pressing Prog +  <i>diSAbLE</i> : the parameter <i>OrIGin</i> can be modified only by entering the programming mode.	<i>diSAbLE</i>
<i>ProGOfS</i>	Direct offset value setting	The parameter allows enabling the direct offset value setting procedure. Use  and  to choose between: <i>EnAbLE</i> : in the operating mode the parameter <i>OFFSEt</i> can be modified by pressing Prog +  <i>diSAbLE</i> : the parameter <i>OFFSEt</i> can be modified only by entering the programming mode.	<i>diSAbLE</i>
<i>Lang</i>	Language	The parameter allows selecting the language. Use  and  to choose between: <i>ItALiAn</i> <i>ENGLiSH</i> <i>dEutSCH</i>	<i>ItALiAn</i>
<i>SEtUP</i>	Sensor calibration procedure	The parameter allows running the calibration procedure. Press Set to start the procedure. See Par. 7 for detailed procedure description.	
<i>dEFAULt</i>	Reset parameters to factory value	Press Set to reset the parameters. A confirmation message is displayed: press Set to confirm, Prog to exit the procedure.	
<i>reL</i>	Software release	The software release is displayed.	<i>EOE</i>